

Varenummer: 20160512

Beskrivelse: Kontramøtrik iso 8675-M12x1,5 Bruneret

Mål

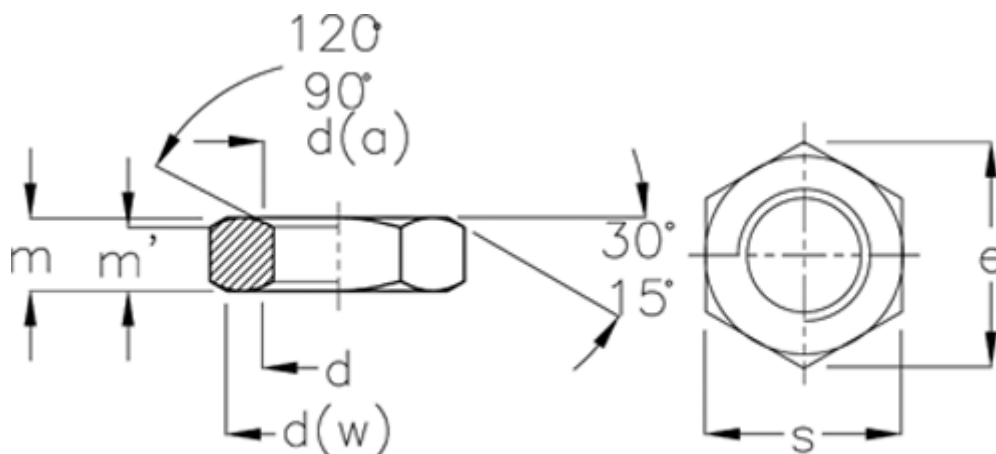

d	= M12	m max = 6
$d1$ max	= 13.00	m min = 5.70
$d1$ min	= 12	s max = 18
$d2$	= M12	s min = 17.73
$d3$	= 1.5	w = 16.63
e	= 20.03	
Gevind stigning	= 1.5	
m	= 4.56	